



MILESTONE

ARCHITECTURAL ORNAMENTATION

Your Home, Our Stone,
A Lifetime Partnership

Catalog 2004

Trims

TRIMS

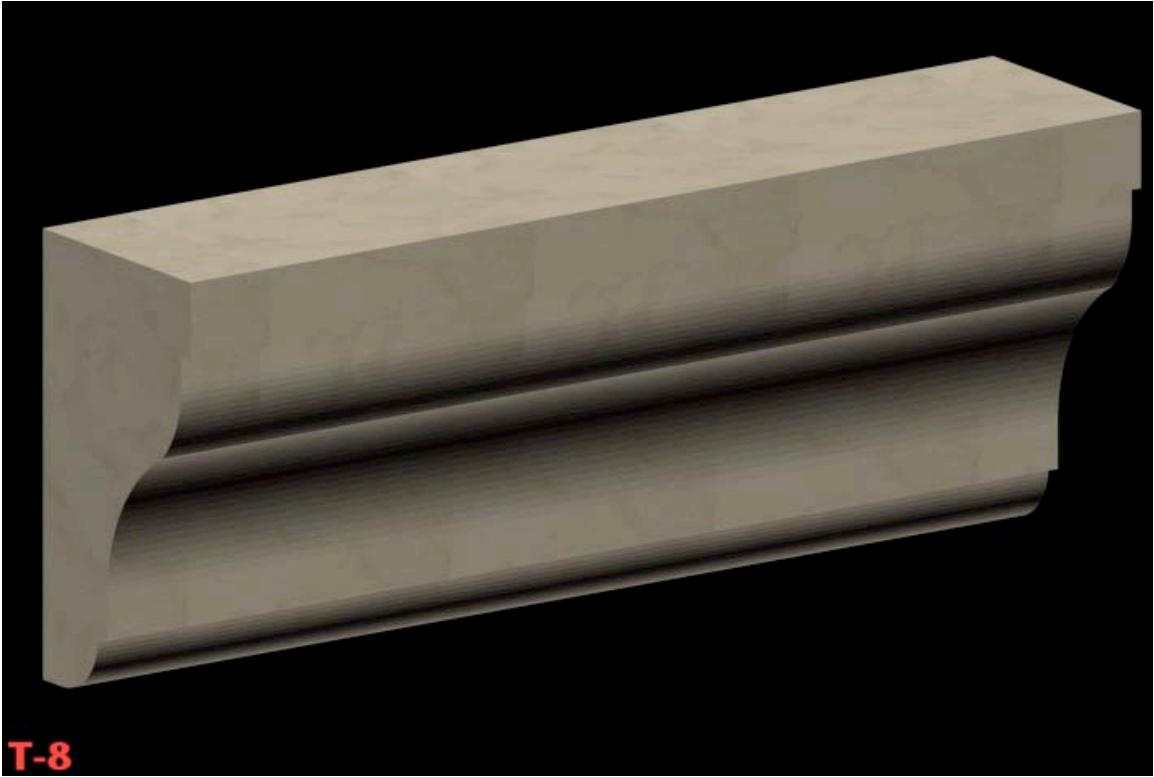

MODEL FINISH DATE: INITIAL: MOLD FINISH DATE: INITIAL:
 THE INFORMATION CONTAINED IN THIS DRAWING IS THE SOLE PROPERTY OF MILESTONE. ANY REPRODUCTION IN PART OR WHOLE WITHOUT THE WRITTEN PERMISSION OF MILESTONE IS PROHIBITED.

WEIGHT: 1.38lb CU. FT. .20 JOB: CATALOG DWG NO. T8

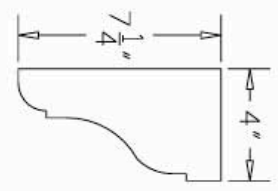

SIDE VIEW
SCALE 1/4"=1"

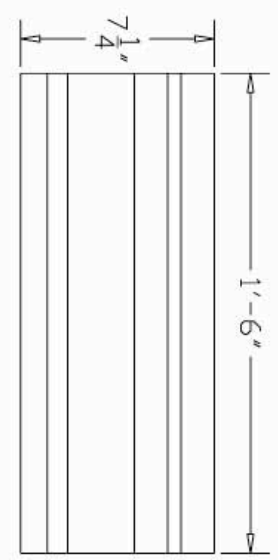

FRONT VIEW
SCALE 1/4"=1"

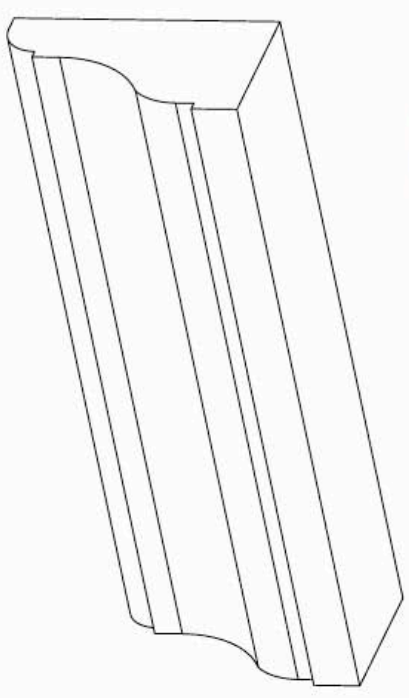

T-8

JOB		CAD GENERATED DRAWING		MILESTONE <i>Design™</i>		REVISIONS		
LINEAR FEET	UNITS	APPROVALS	DATE	AMARILLO, TX 79107	REV.	DESCRIPTION	DATE	APPROVED
PIECE COUNT	COLOR	Robert J.	6/29/04	888-851-3381 WWW.MILESTONELTD.COM				
FINISH	SCALE	ENGINEER	APPROVED	TRIM	SIZE	DWG. NO.	REV.	
		APPROVED			B	T8		
					CAD FILE:	SHEET 100		

Milestone hereby disclaims all liability for, and is not responsible or liable for, any damages or costs that may result from improper installation or use of its products.

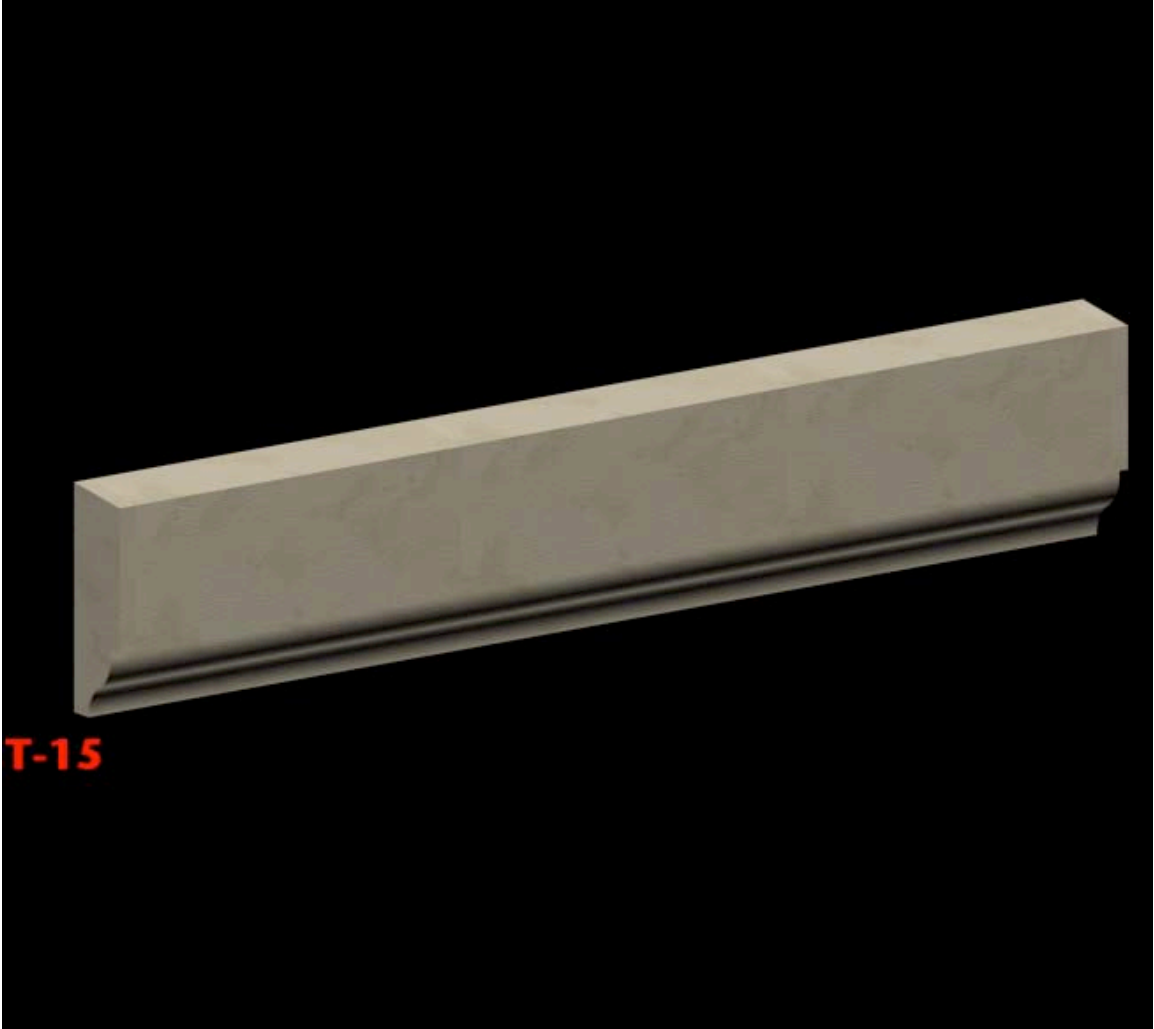

MODEL FINISH DATE: INITIAL: MOLD FINISH DATE: INITIAL:
 THE INFORMATION CONTAINED IN THIS DRAWING IS THE SOLE PROPERTY OF MILESTONE. ANY REPRODUCTION IN PART OR WHOLE WITHOUT THE WRITTEN PERMISSION OF MILESTONE IS PROHIBITED.

WEIGHT: 12LBS CU. FT. .18 JOB: CATALOG DWG NO. T15

T-15

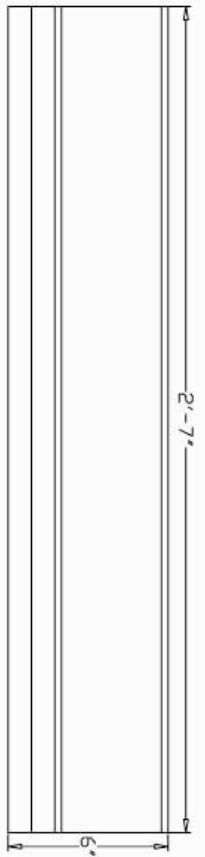
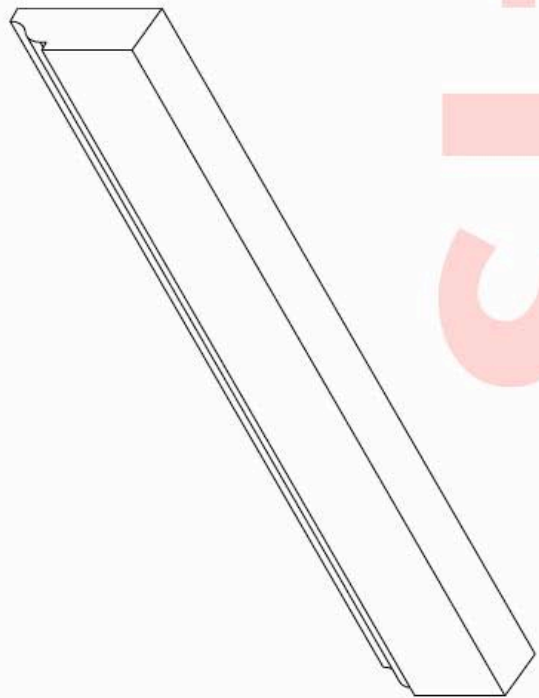
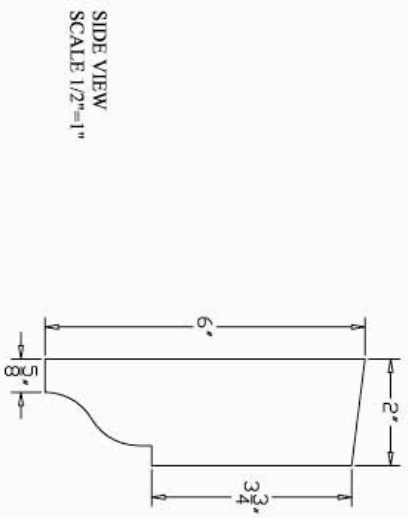

JOB	LINEAR FEET	CAD GENERATED DRAWING	MILESTONE Design™ AMARILLO, TX 79107 888-851-3381 WWW.MILESTONELTD.COM		REVISIONS REV. DESCRIPTION DATE APPROVED	
	UNITS	APPROVALS	DATE	Milestone hereby disclaims all liability for, and is not responsible or liable for, any damages or costs that may result from improper installation or use of its products.		
	PIECE COUNT	DRAWN: Robert J. CHECKED:	6/29/04			
	COLOR	ENGINEER				
	FINISH	APPROVED				
	SCALE	APPROVED		SIZE: B DWG. NO: T15 CAD FILE: SHEET 100	REV.	

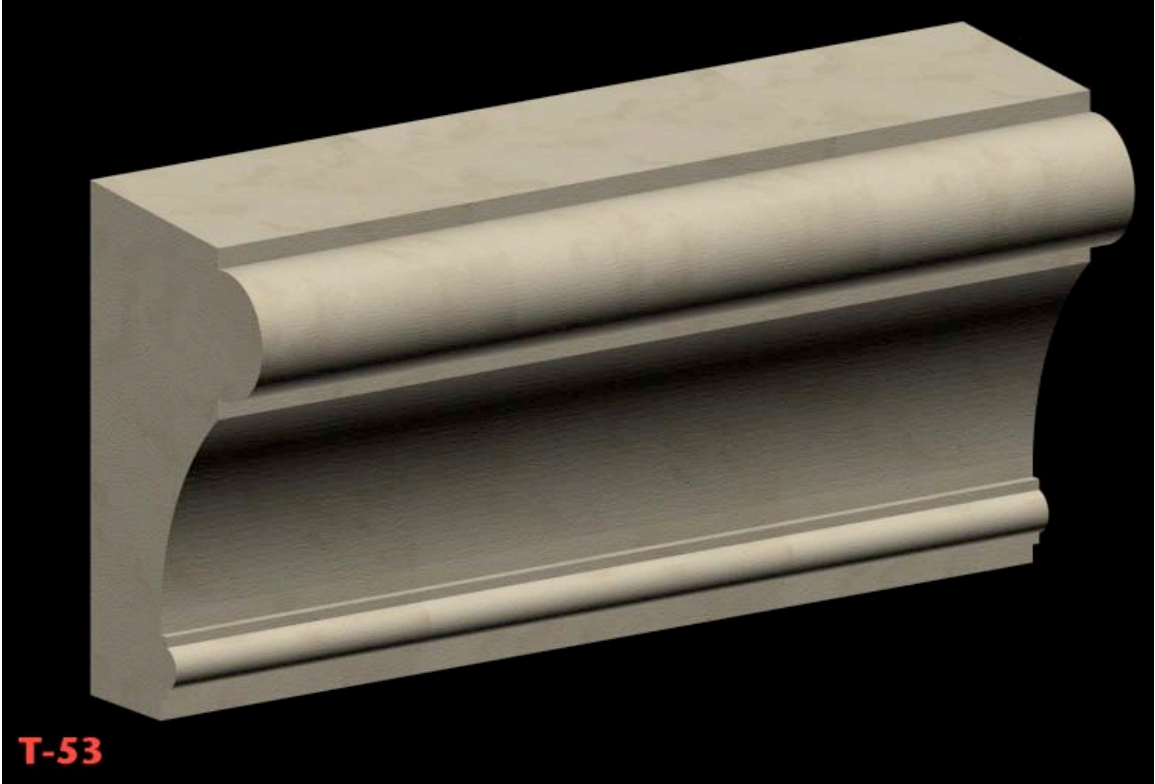

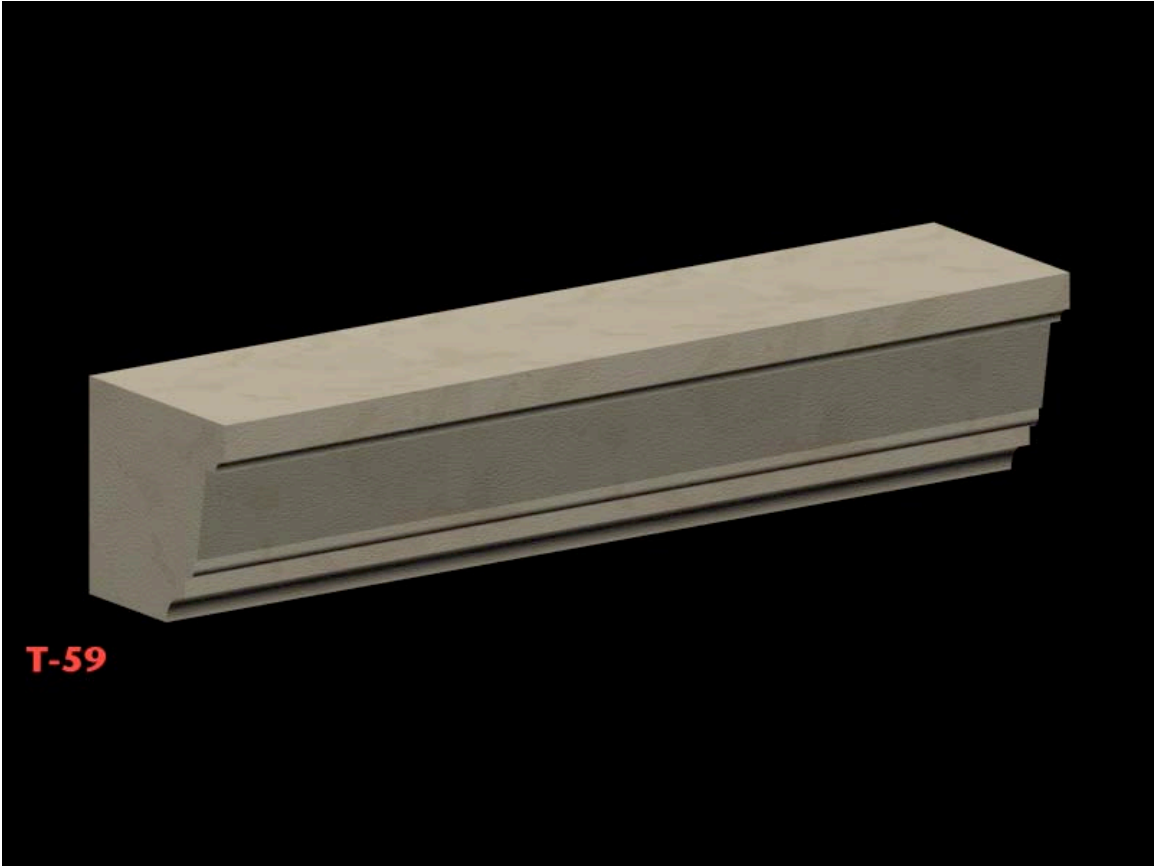

T-59

MODEL FINISH DATE: INITIAL: MOLD FINISH DATE: INITIAL:
 THE INFORMATION CONTAINED IN THIS DRAWING IS THE SOLE PROPERTY OF MILESTONE. ANY REPRODUCTION IN PART OR WHOLE WITHOUT THE WRITTEN PERMISSION OF MILESTONE IS PROHIBITED.

WEIGHT: 22lbs CU. FT. .33 JOB: CATALOG DWG NO. T59

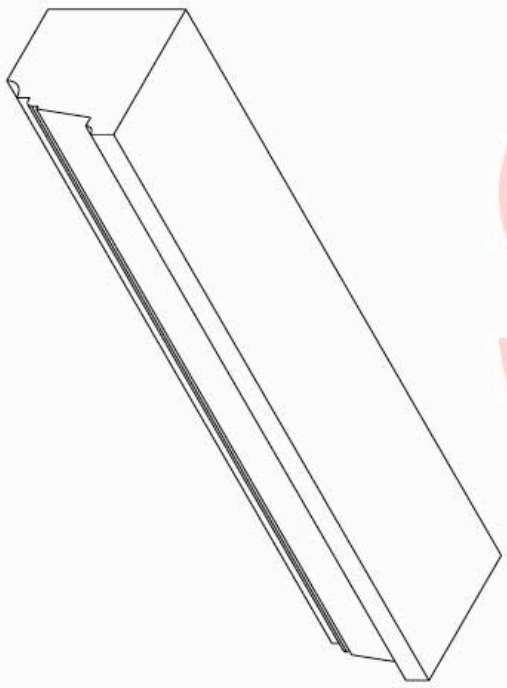
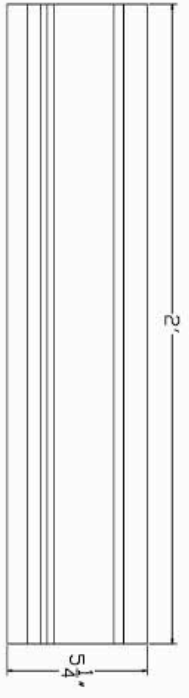
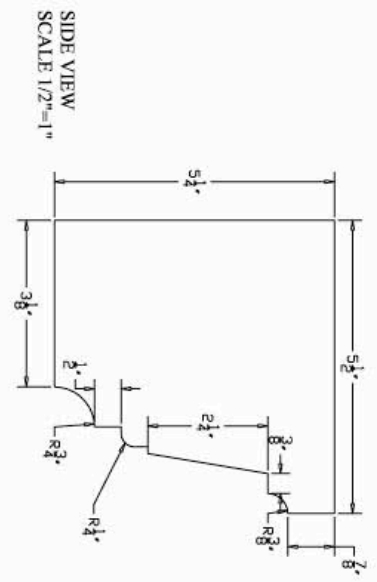

T-59

JOB		CAD GENERATED DRAWING		MILESTONE <i>Design™</i>		REVISIONS		
LINEAR FEET	UNITS	APPROVALS	DATE	AMARILLO, TX 79107	REV.	DESCRIPTION	DATE	APPROVED
		Robert J.	6/29/04	888-851-3381 WWW.MILESTONELTD.COM				
PIECE COUNT	COLOR	CHECKED	ENGINEER	TRIM				
				SIZE B	DWG. NO. T59	REV.		
FINISH	SCALE	APPROVED	APPROVED	CAD FILE:	SHEET 100			
						Milestone hereby disclaims all liability for, and is not responsible or liable for, any damages or costs that may result from improper installation or use of its products.		

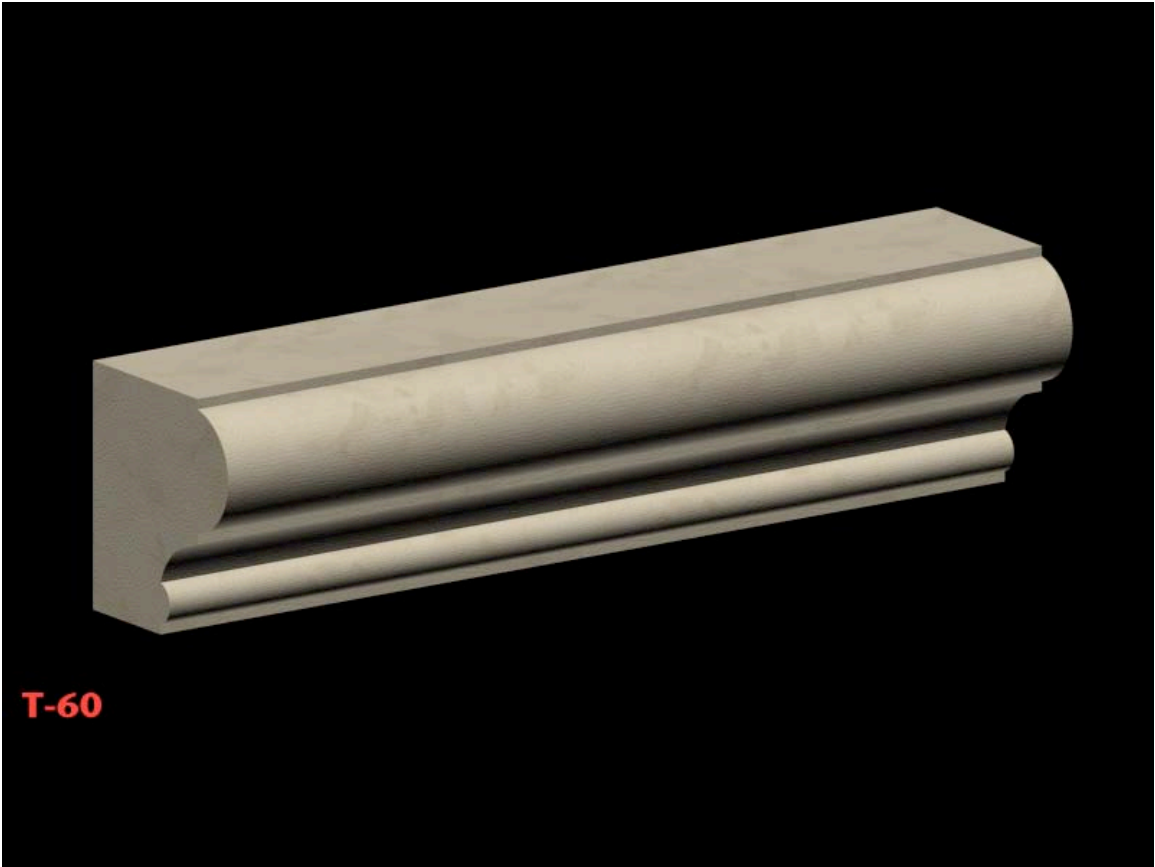

T-60

MODEL FINISH DATE: INITIAL: MOLD FINISH DATE: INITIAL:
 THE INFORMATION CONTAINED IN THIS DRAWING IS THE SOLE PROPERTY OF MILESTONE. ANY REPRODUCTION IN PART OR WHOLE WITHOUT THE WRITTEN PERMISSION OF MILESTONE IS PROHIBITED.

WEIGHT: 23lbs CU. FT. .35 JOB: CATALOG DWG NO. T60

T-60

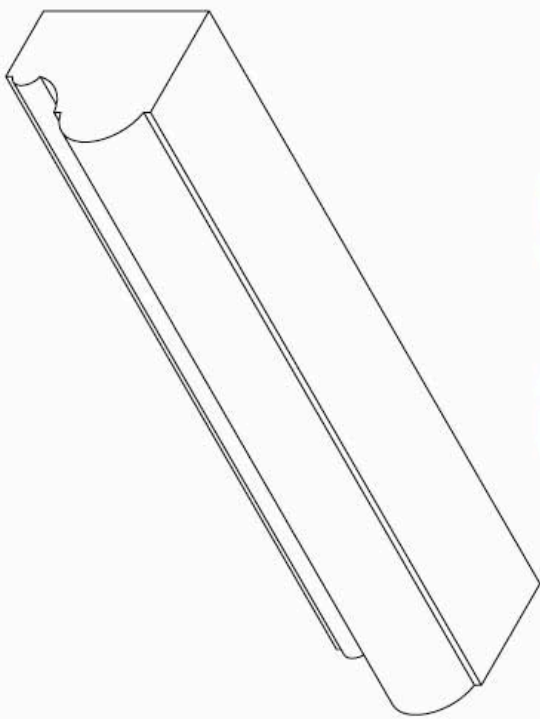
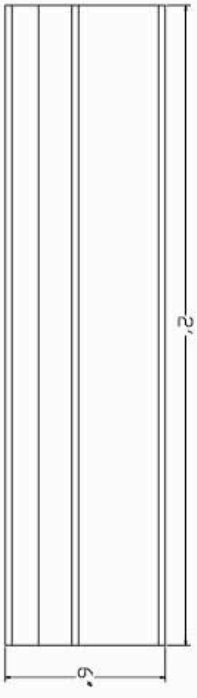
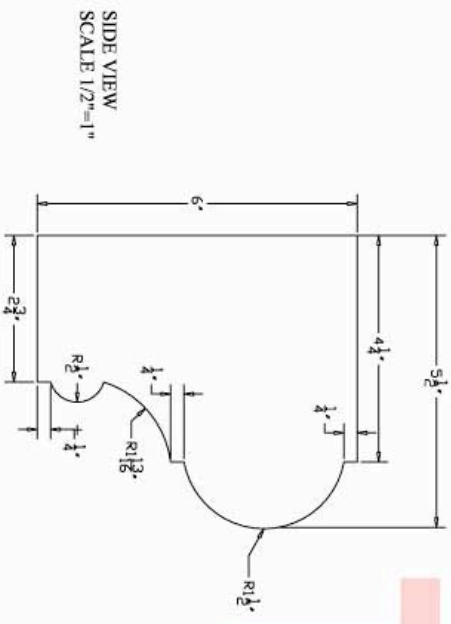

LINEAR FEET		CAD GENERATED DRAWING		MILESTONE <i>Design™</i>		REVISIONS		
UNITS		APPROVALS	DATE	AMARILLO, TX 79107	REV.	DESCRIPTION	DATE	APPROVED
PIECE COUNT		DRAWN	6/29/04	888-851-3381 WWW.MILESTONE.LTD.COM				
COLOR		CHECKED						
FINISH		ENGINEER						
SCALE		APPROVED						
		APPROVED			SIZE	DWG. NO.	REV.	
					B	T60		
					CAD FILE:		SHEET	100

Milestone hereby disclaims all liability for, and is not responsible or liable for, any damages or costs that may result from improper installation or use of its products.