

# MILESTONE

MILESTONE ARCHITECTURAL ORNAMENTATION, INC.  
4225 NE 9TH AVENUE  
AMARILLO, TEXAS 79107  
TOLL FREE: 1-888-851-3381  
PHONE: (806) 381-4030  
FAX: (806) 381-6996  
www.milestoneltd.com

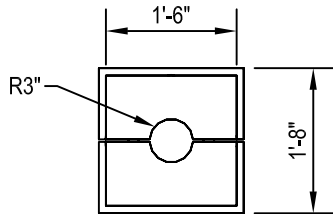

TOP VIEW

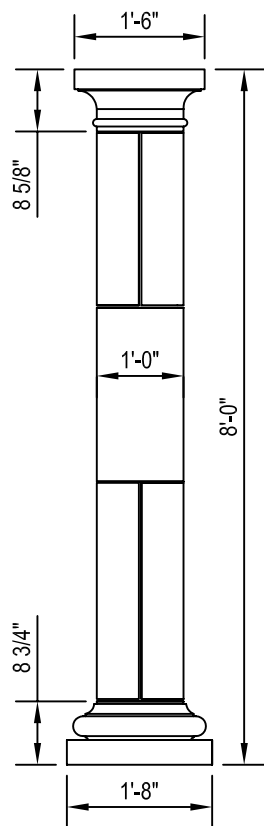

FRONT VIEW

SPECIFICATION SHEET  
CATALOG NUMBER: COL-1  
12" STRAIGHT 8'HT COLUMN  
WEIGHT: 269LBS  
CUFT: 4.1  
WEIGHTS AND CUFT ARE AT  
SHOWN HEIGHT

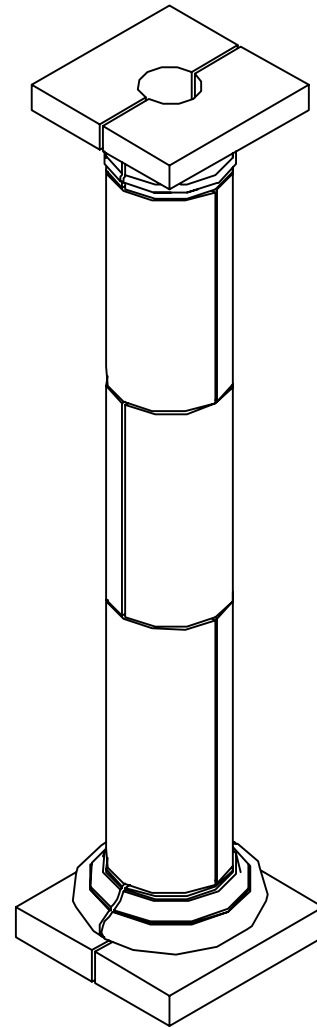

ISOMETRIC VIEW

**NOTES:**

1. INSTALLATION TO BE COMPLETED IN ACCORDANCE WITH MANUFACTURERS SPECIFICATIONS.
2. DO NOT SCALE DRAWINGS.
3. CONTRACTORS NOTE: FOR PROJECT AND PURCHASING INFORMATION VISIT [www.CADdetails.com/info](http://www.CADdetails.com/info) REFERENCE NUMBER 419-172.

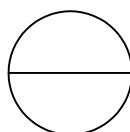

**COLUMN**

MODEL COL-1, 12 INCH DIAMETER